

EVOLUTION

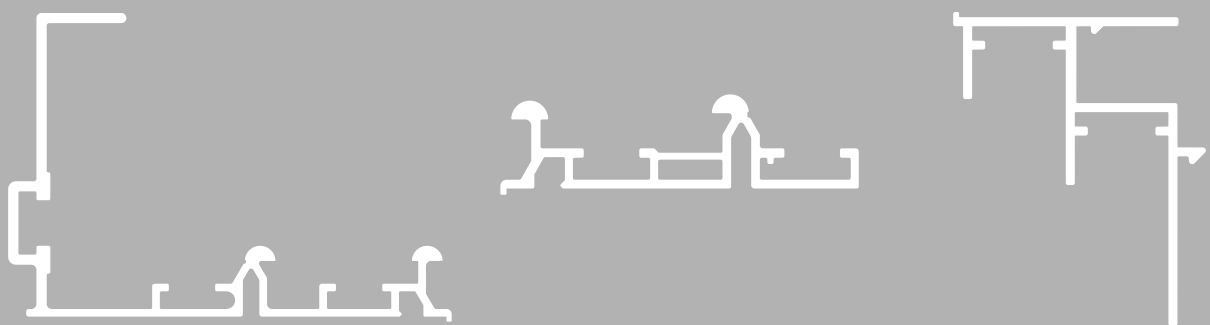



Gruppo Pozzi

SOLUZIONI A DUE E TRE ANTE / Three-doors and two-doors solutions

SISTEMA SCORREVOLE REGOLABILE PER ANTE SOVRAPPOSTE

Portata, fino ad 80 kg per anta.

Carrello inferiore con aggancio automatico e dispositivo di sicurezza per evitare lo sganciamento accidentale dell'anta (brevettato).

Carrello superiore dotato di dispositivo di anti-scarrucolamento dell'anta.

Carrelli reversibili (brevettato).

Disponibile con fermi standard e con sistema di richiamo e chiusura frenata dell'anta.

Con sistema di regolazione della perpendicolarità dell'anta esterna (brevettato).

ADJUSTABLE SLIDING SYSTEM FOR OVERLAPPING DOORS

Load capacity 80 kg.

Lower sliders with automatic locking device and with safety system to prevent accidental door release (patented).

Upper trucks with anti-derailment safety device.

Reversible trucks (patented).

Available both with standard stoppers and with soft closing devices.

Equipped with system to adjust perpendicularity of external door (patented).



Vista dall'alto
Top view



DUE ANTE / Two doors



TRE ANTE / Three doors

DIMENSIONI E DATI TECNICI / System Dimension and data sheets

SEZIONE VISTA LATERALE / Side view section

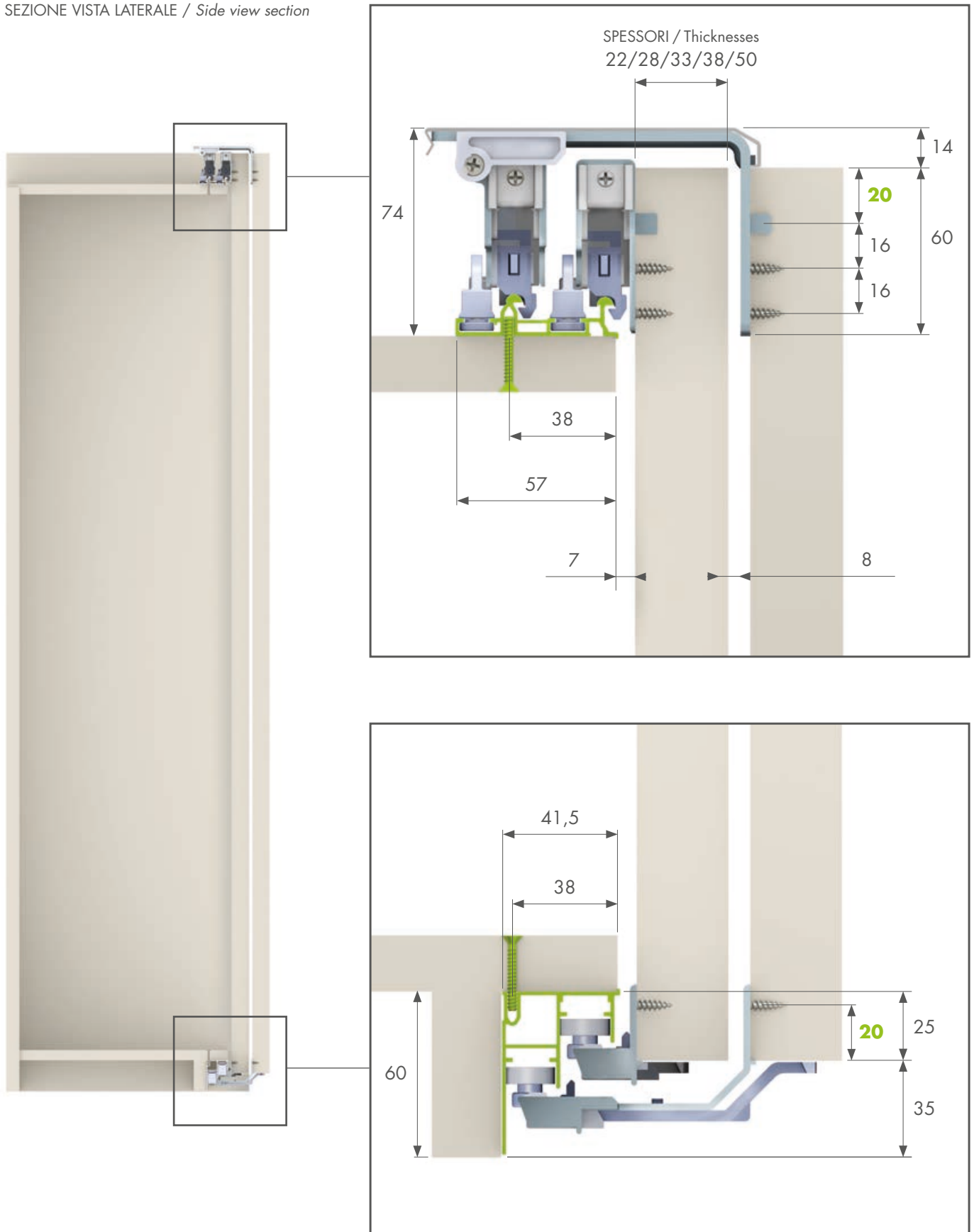

COMPONENTI DEL SISTEMA / System Components

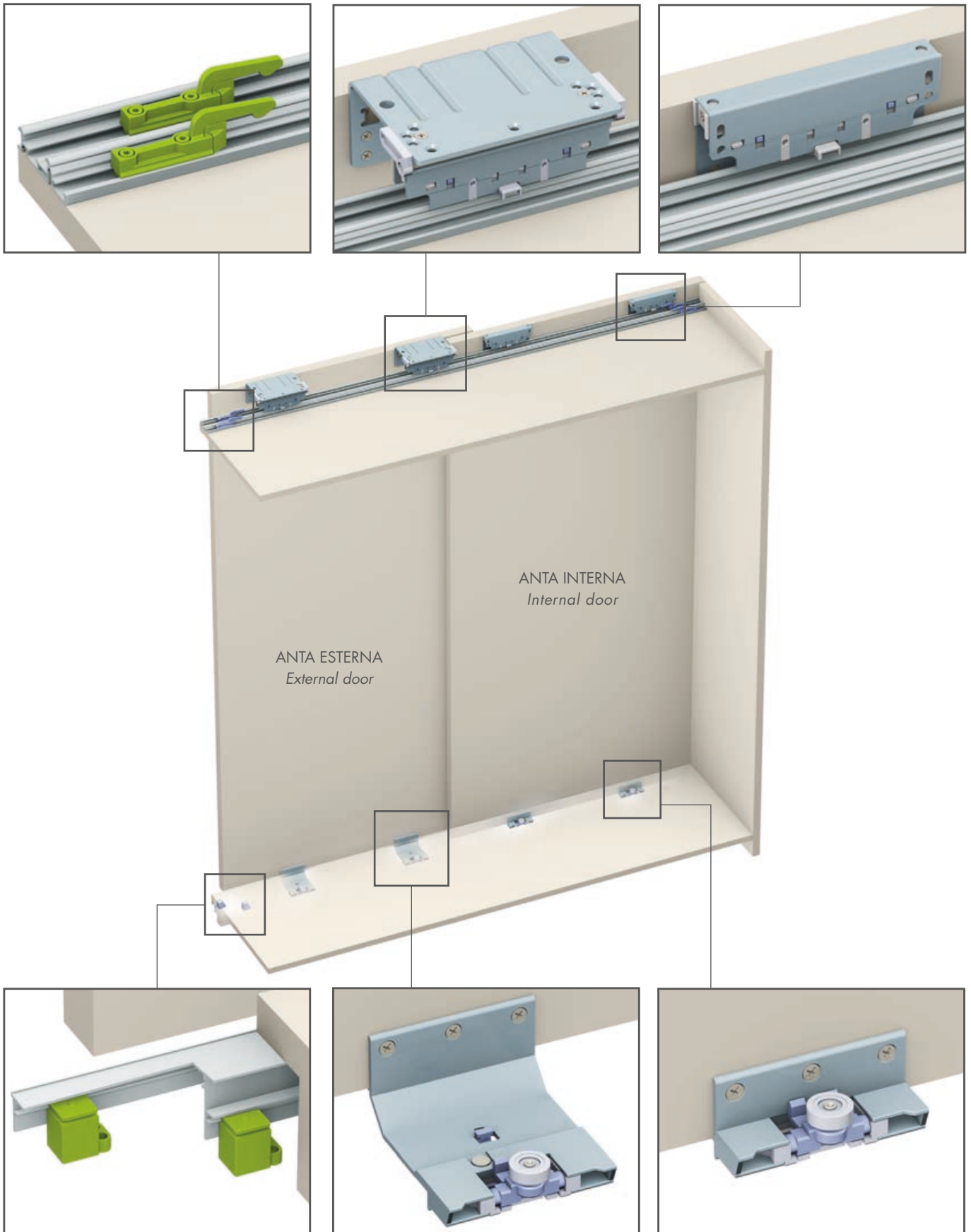

DIMENSIONI E DATI TECNICI / System Dimension and data sheets

SEZIONE VISTA LATERALE / Side view section

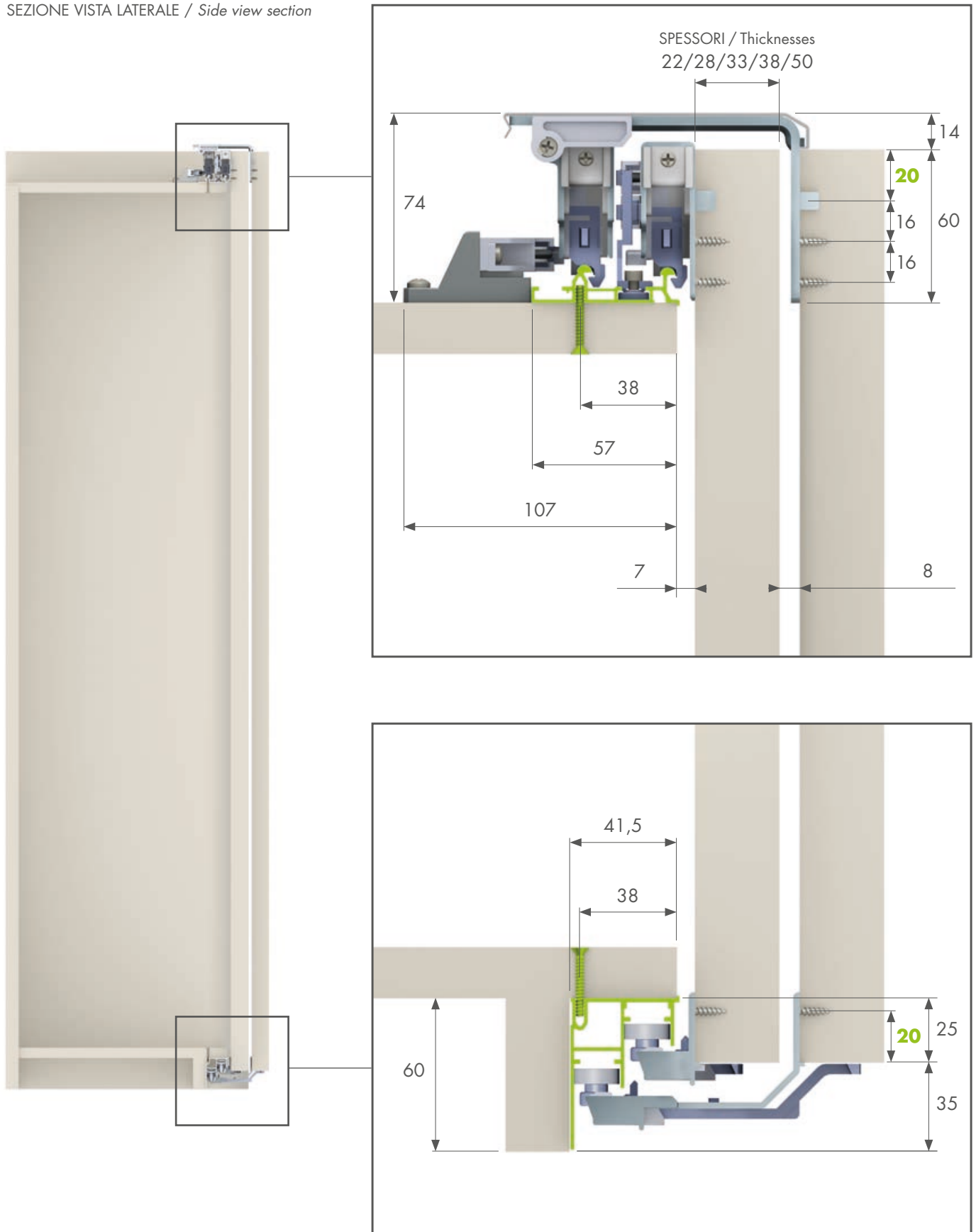

COMPONENTI DEL SISTEMA / System Components

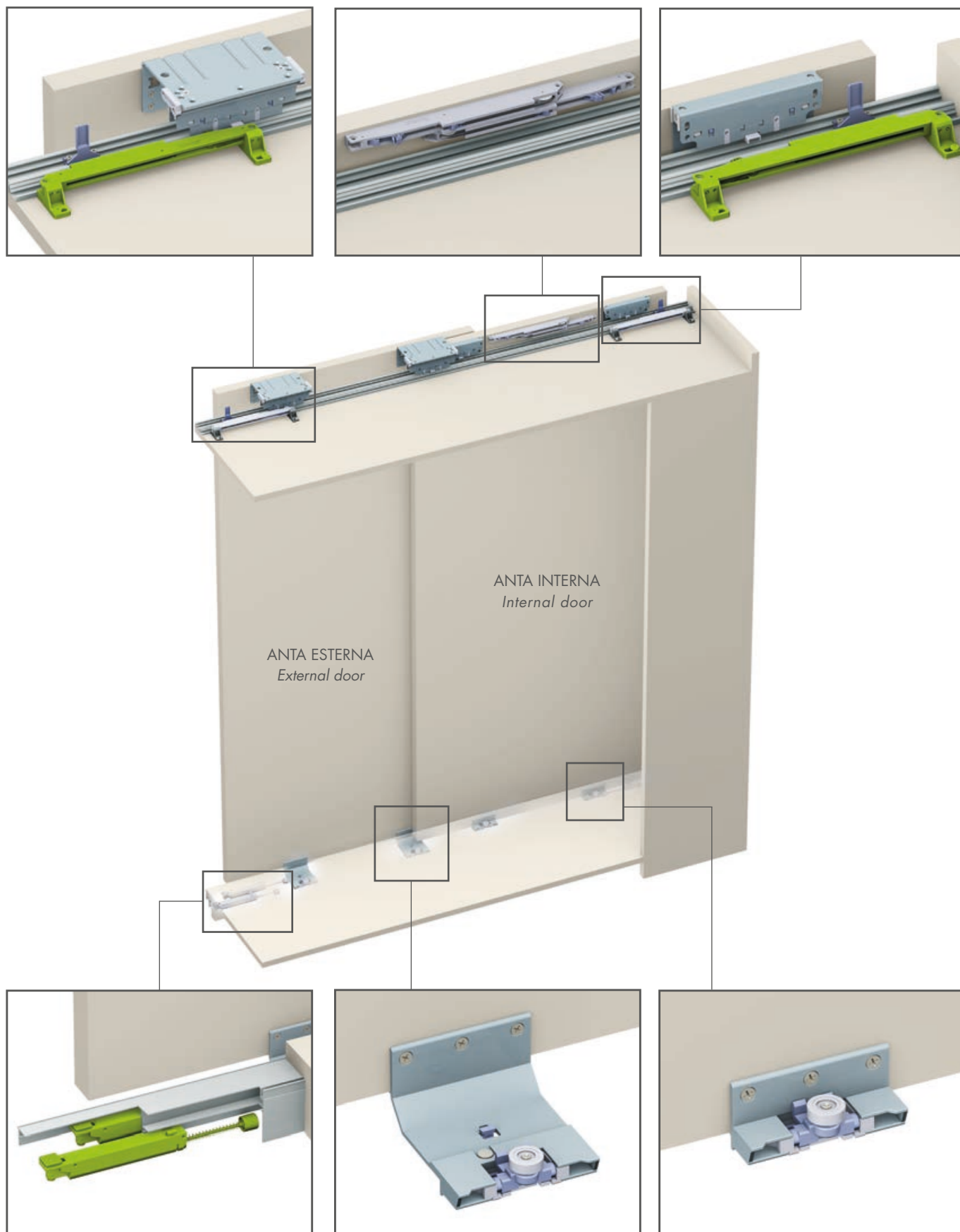

DIMENSIONI E DATI TECNICI / System Dimension and data sheets

SEZIONE VISTA LATERALE / Side view section

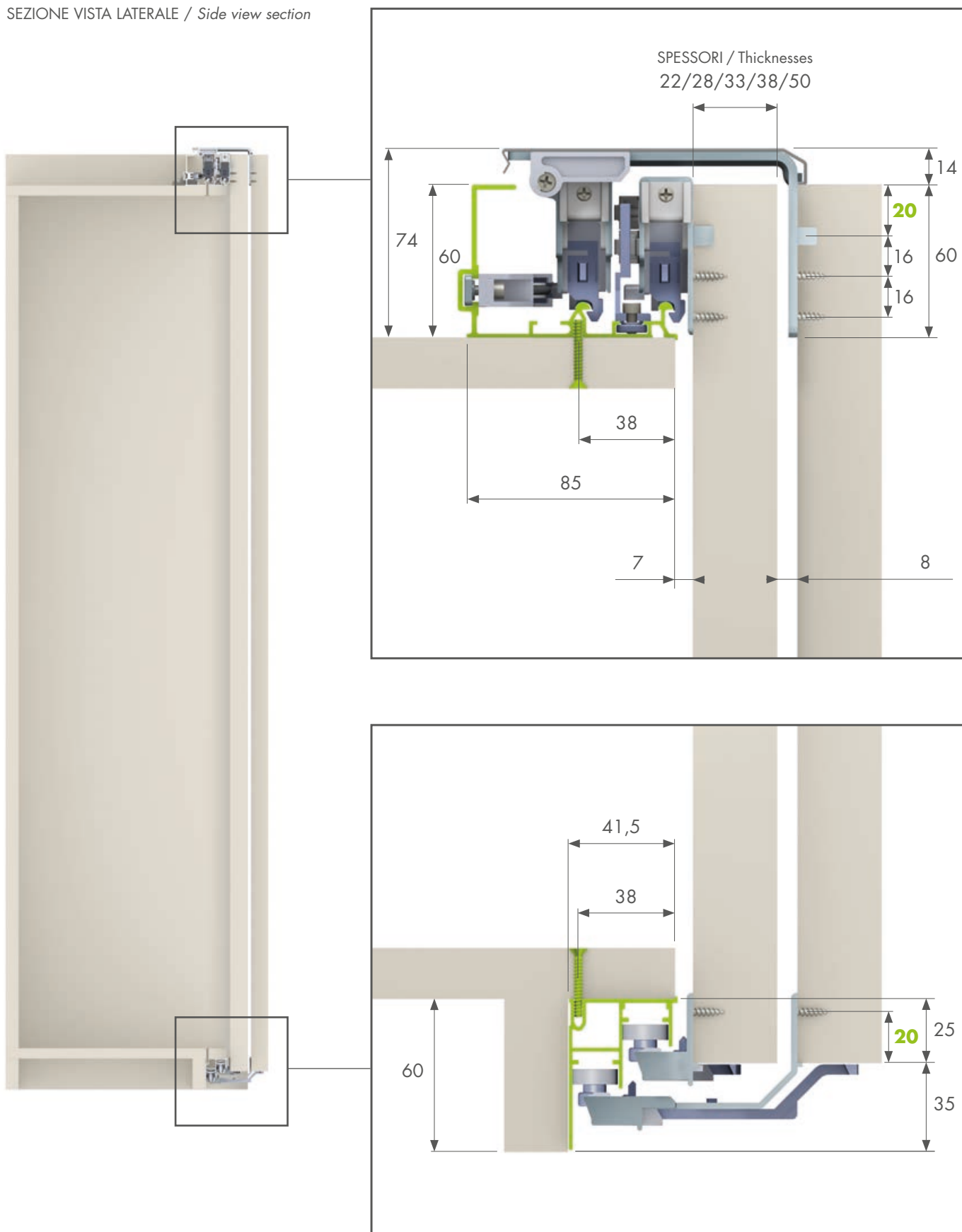

COMPONENTI DEL SISTEMA / System Components

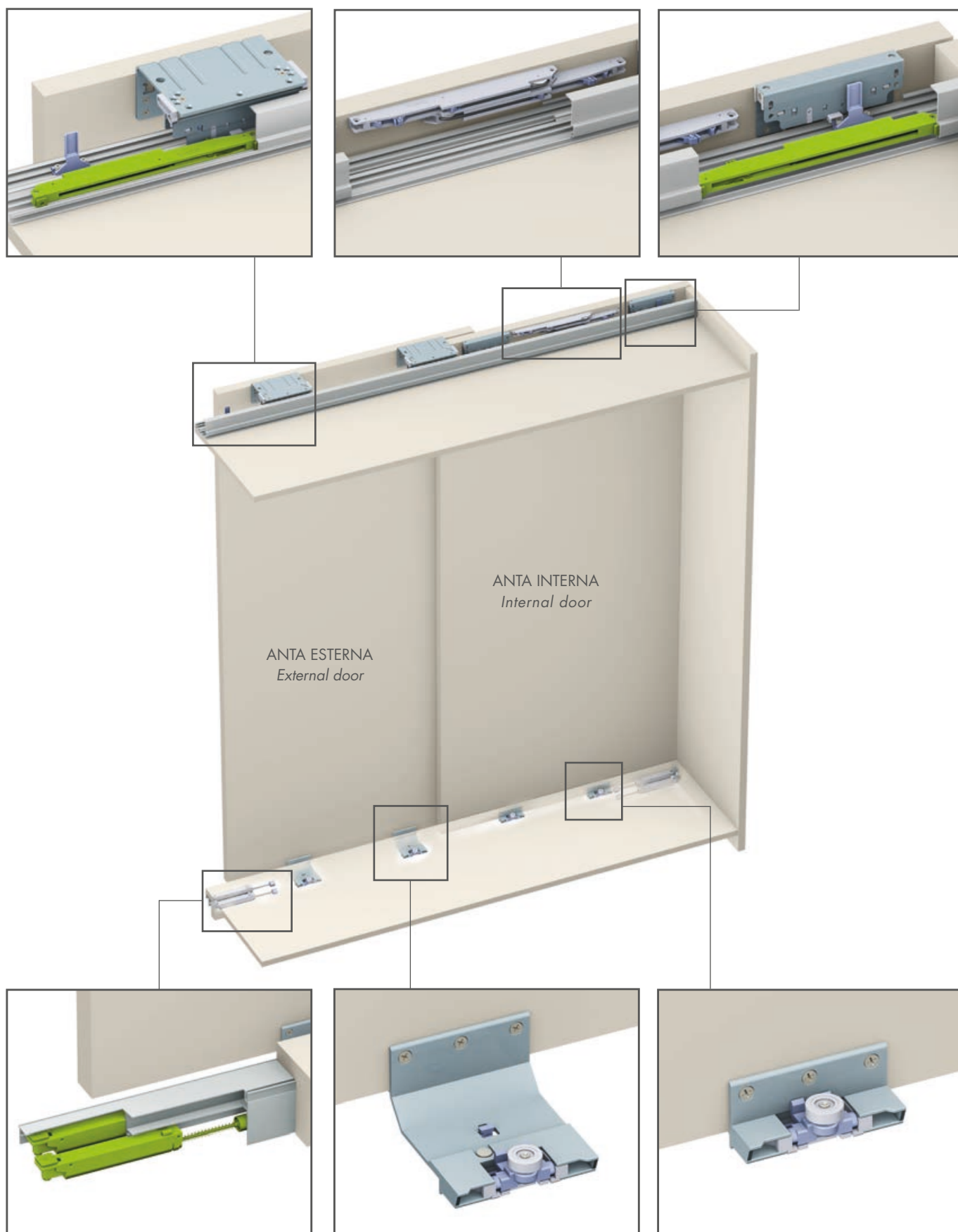

COMPONENTI / Parts list

000K233----2

Kit anta esterna spessore fino a 22 mm
External door kit, maximum thickness 22 mm

000K234----2

Kit anta esterna spessore fino a 28 mm
External door kit, maximum thickness 28 mm

000K242----2

Kit anta esterna spessore fino a 33 mm
External door kit, maximum thickness 33 mm

000K235----2

Kit anta esterna spessore fino a 38 mm
External door kit, maximum thickness 38 mm

000K278----2

Kit anta esterna spessore fino a 50 mm
External door kit, maximum thickness 50 mm



000K232----2

Kit anta interna completa di fine corsa e salva maniglia
000K231----0
Internal door kit with stopper and spacer for handles
000K231----0

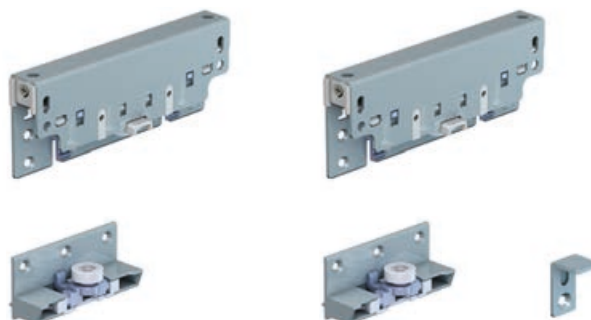

000K228----42

Kit fermi per un'anta
Stoppers kit for one door



000K338----0

NEW

Ammortizzatore superiore con regolazione della forza di chiusura, completo di minuteria per binario **010716**. Corsa 50 mm. *Upper soft closing, with adjustable closing power, complete with fixing accessories for rail 010716. Stroke 50 mm.*



000K339----0

NEW

Ammortizzatore superiore con regolazione della forza di chiusura, completo di minuteria per binario **011034**. Corsa 50 mm. *Upper soft closing, with adjustable closing power, complete with fixing accessories for rail 011034. Stroke 50 mm.*



COMPONENTI / Parts list

000T215----42

Ammortizzatore superiore con molla standard con minuteria per binario **010716**. Corsa 70 mm.
Upper soft closing with standard spring, complete with fixing accessories for rail **010716**. Stroke 70 mm.



000T215-1--42

Ammortizzatore superiore con molla forte (L=78mm) con minuteria per binario **010716**. Corsa 70 mm.
Upper soft closing with strong spring (L=78mm), complete with fixing accessories for rail **010716**. Stroke 70 mm.

000T215-2--42

Ammortizzatore superiore con molla debole (L=98mm) con minuteria per binario **010716**. Corsa 70 mm.
Upper soft closing with soft spring (L=98mm), complete with fixing accessories for rail **010716**. Stroke 70 mm.

000T216----42

Ammortizzatore inferiore
Lower soft closing



000T218----3P

Fermo per ammortizzatore **000T215----42**
Stopper for soft closing **000T215----42**



000K230----0

Kit chiavi per Evolution
Wrenches kit for Evolution



PROFILI / Profiles

010716

Binario superiore.
Upper rail.

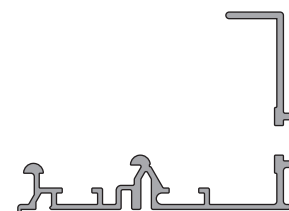

011034

Binario superiore.
Upper rail.



011035

Binario inferiore.
Lower rail.

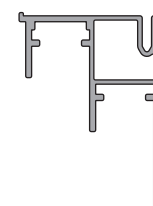

010644

Carter per anta esterna / **Fin. 00** grezzo.
Cover profile for external door / Fin.00 raw.



NEW

VERSIONE CON BINARIO 011070 PER FISSAGGIO RAPIDO SENZA UTENSILI / Upper rail 011070 for assembly without tools



DIMENSIONI E DATI TECNICI / System Dimension and data sheets

Il binario superiore 011070 può essere fissato anche tramite viti, sia in abbinamento al binario inferiore **010805** con aggancio a scatto, sia con il binario **011035** fissaggio a vite.

*Upper rail 011070 can be fixed also by screws together with lower rail **010805** fixing without tools or with rail **011035** screw-on fixing.*

SEZIONE VISTA LATERALE / Side view section

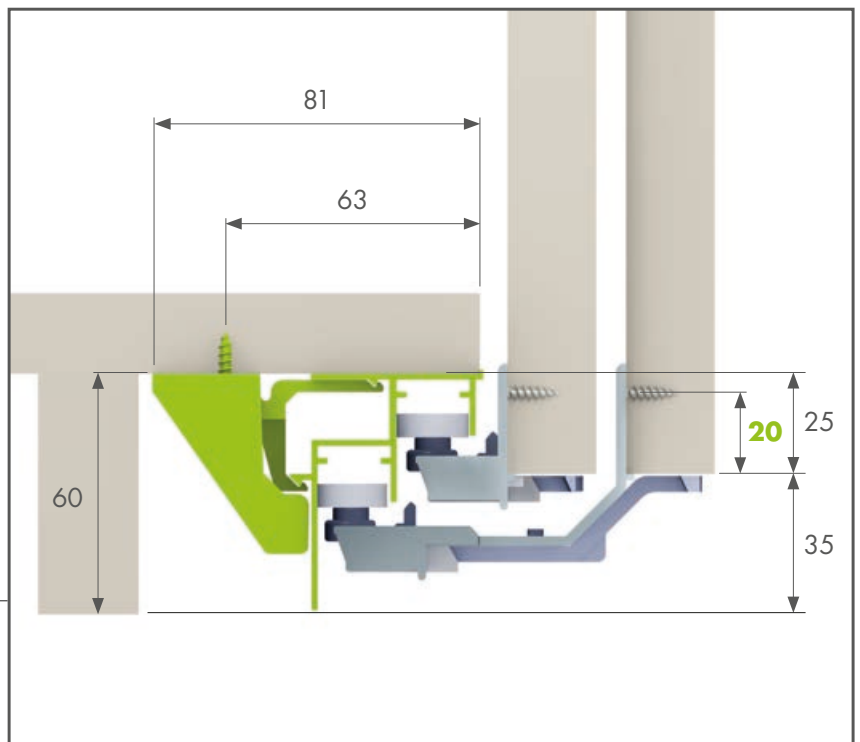
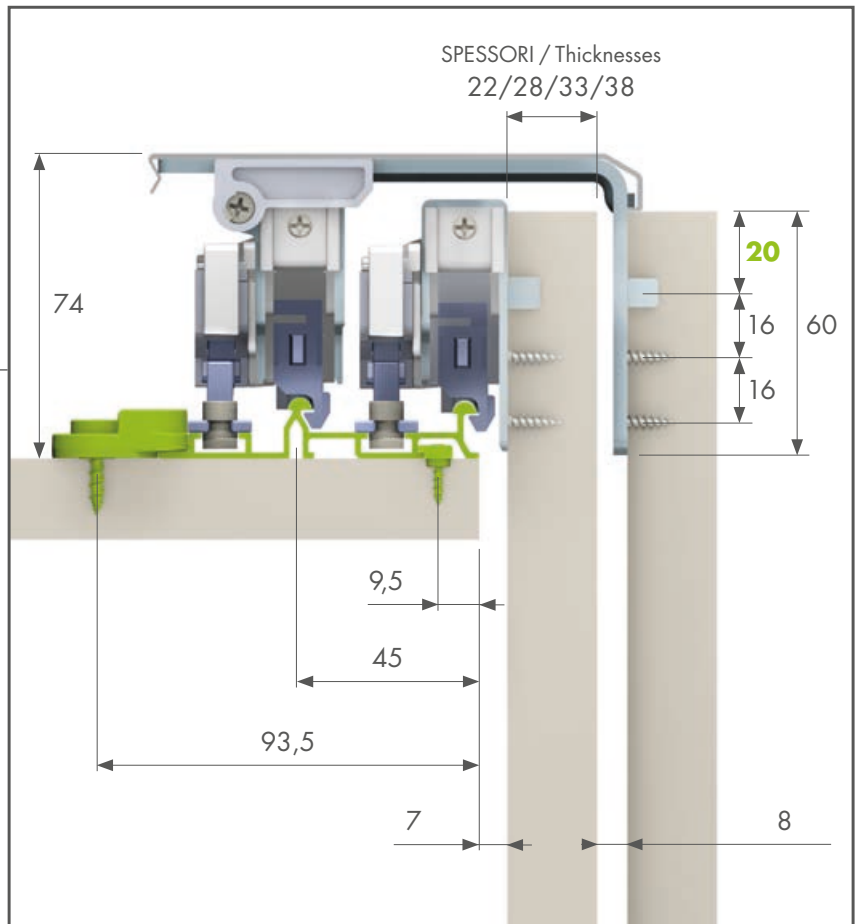

NEW

AMMORTIZZATORI SUPERIORI MONTATI SUI CARRELLI

Upper soft closing assembled on the upper roller



COMPONENTI DEL SISTEMA / System Components

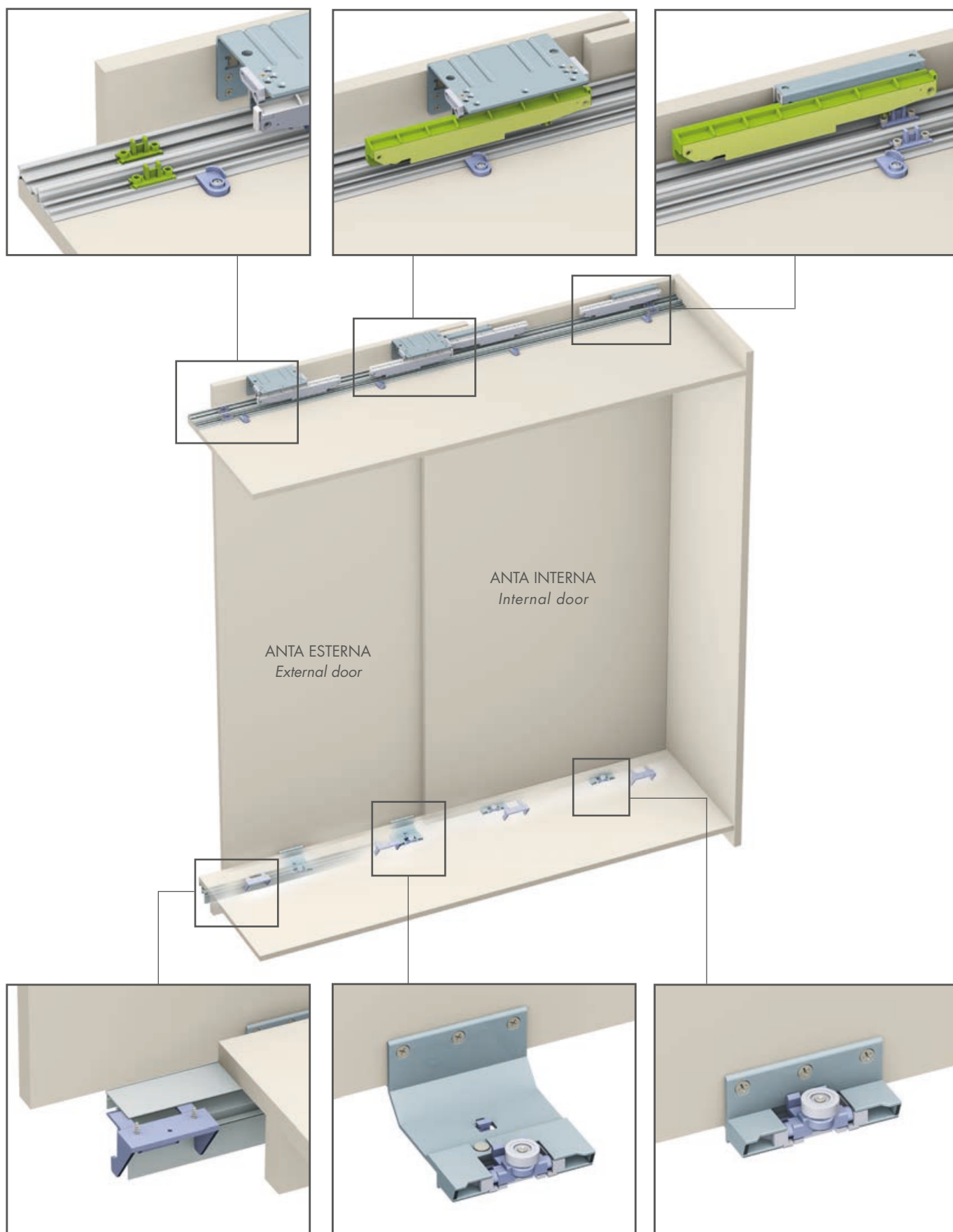

COMPONENTI / Parts list

000K234-22-2

Kit anta esterna spessore fino a 22 mm
External door kit, maximum thickness 22 mm

000K242-28-2

Kit anta esterna spessore fino a 28 mm
External door kit, maximum thickness 28 mm

000K235-33-2

Kit anta esterna spessore fino a 33 mm
External door kit, maximum thickness 33 mm

000K278-38-2

Kit anta esterna spessore fino a 38 mm
External door kit, maximum thickness 38 mm



000K232-2--2

Kit anta interna
Internal door kit

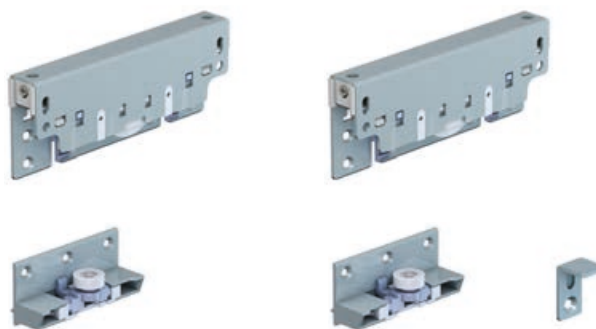

000S040----42

NEW

Coppia supporti destra/sinistra per fissaggio ammortizzatore **000T321----0**
Kit of fixing supports (left and right) for damper **000T321----0**



000T321----0

NEW

Ammortizzatore superiore con regolazione della forza di chiusura. Corsa 50 mm.
Upper soft closing, with adjustable closing power. Stroke 50mm.



000K356----0

NEW

Kit fissaggio binario superiore. Utilizzare un kit per ogni metro lineare.
Fixing kit for upper rail. Use one kit per linear meter.



000V343----42

NEW

Supporto per aggancio binario inferiore senza utensili. Utilizzare due pezzi per ogni metro lineare.
Bracket for assembly of lower rail without tools. Use two pieces per linear meter.



COMPONENTI / Parts list

000T216----42

Ammortizzatore inferiore
Lower soft closing



01CT324----3P

Fermo per ammortizzatore
Stopper for soft closing



000K230----0

Kit chiavi per Evolution
Wrenches kit for Evolution



PROFILI / Profiles

011070

Binario superiore.
Upper rail.



010805

Binario inferiore.
Lower rail.

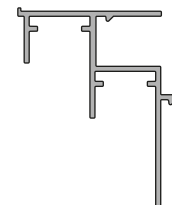

011035

Binario inferiore.
Lower rail.

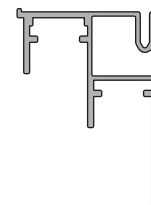

010644

Carter per anta esterna / **Fin. 00** grezzo.
Cover profile for external door / **Fin. 00** raw.



REGOLAZIONE VERTICALE / Vertical adjustments

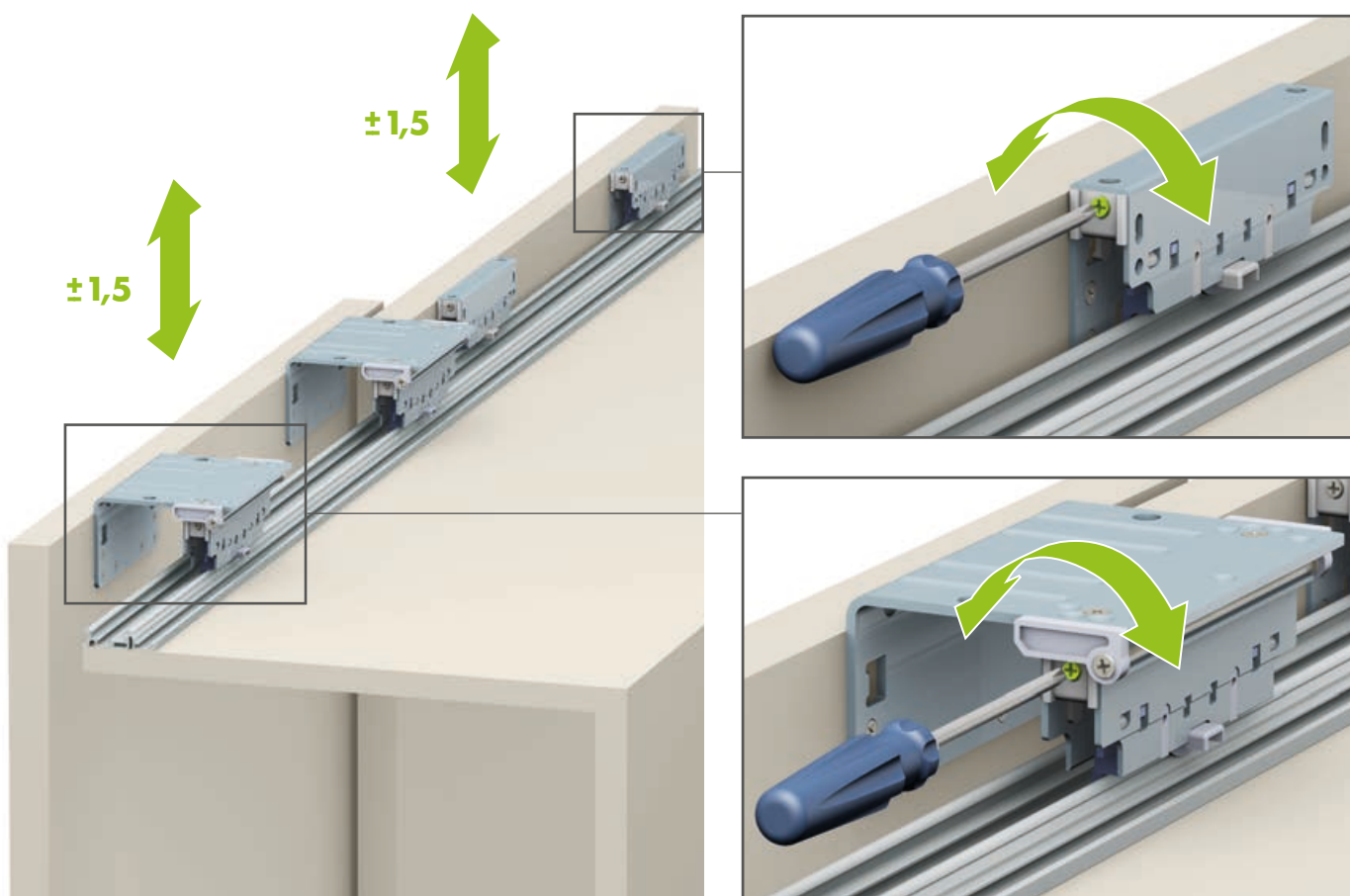

REGOLAZIONE ASSIALE ANTA ESTERNA / Axial adjustments external door

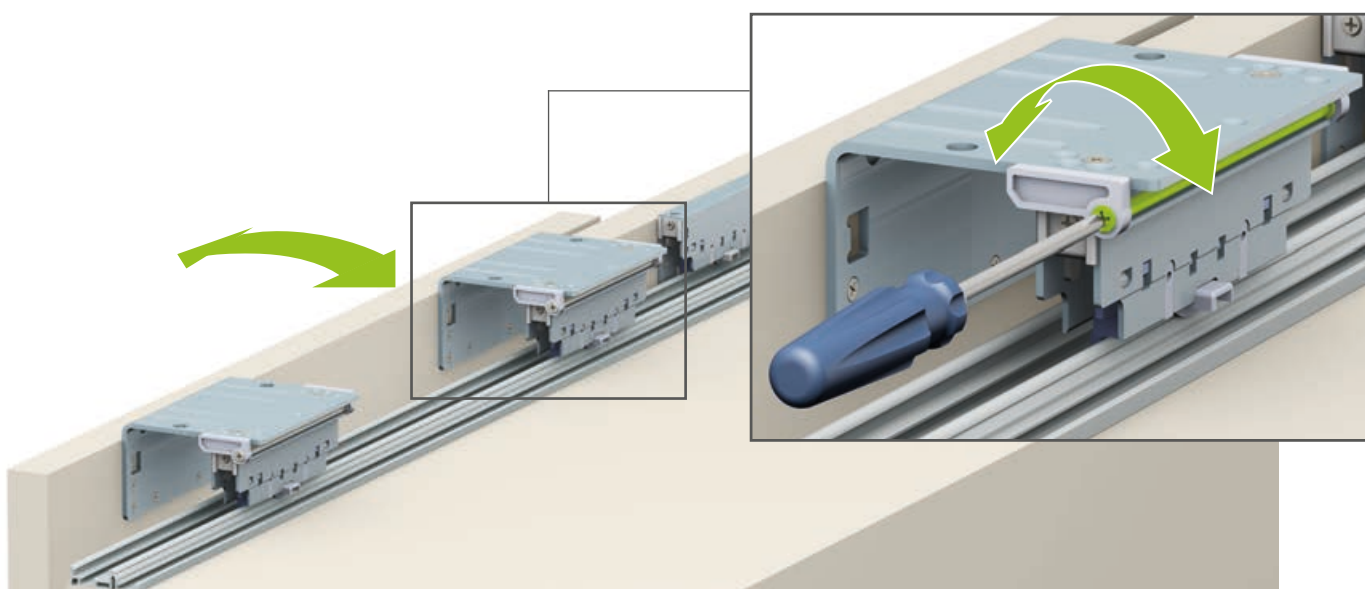

ANTISCARRUCOLAMENTO SUPERIORE Upper anti-derailment safety device

ANTISCARRUCOLAMENTO **DISATTIVATO**
Anti-fleeting device disabled

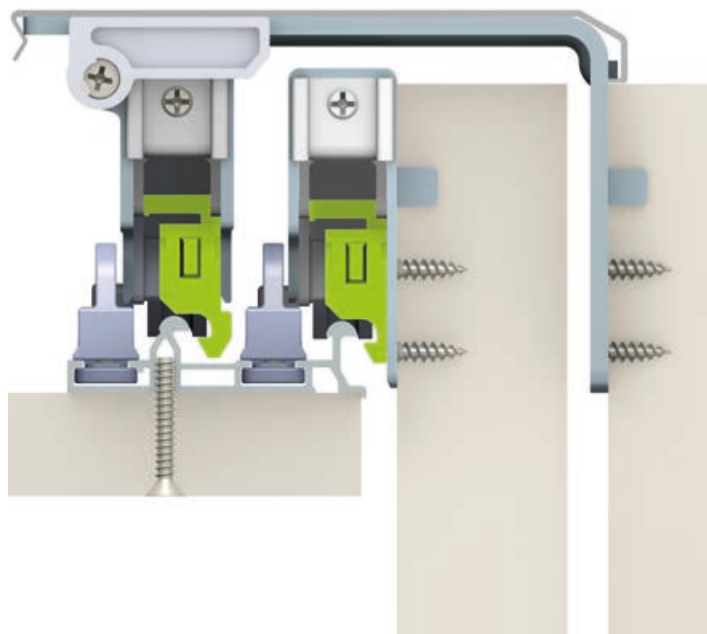

ANTISCARRUCOLAMENTO **ATTIVATO**
Anti-fleeting device activated

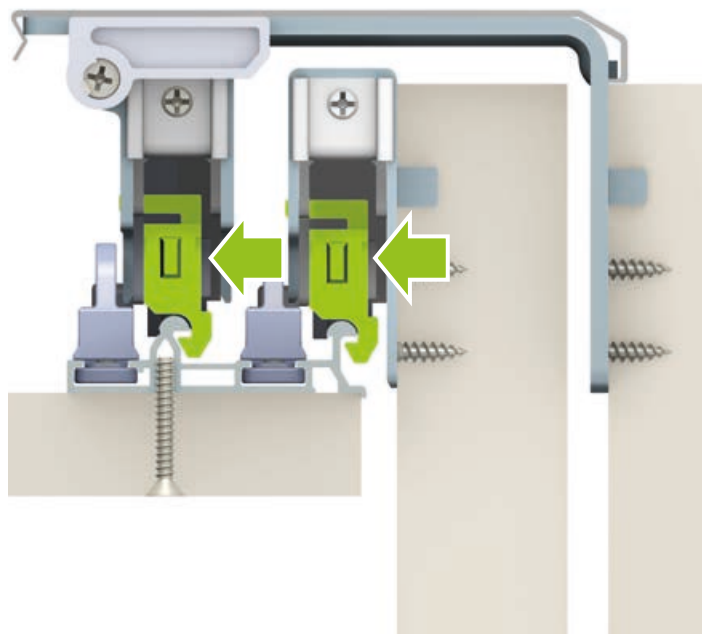

ANTISGANCIAMENTO AUTOMATICO INFERIORE Automatic lower safety device

ANTISGANCIAMENTO **DISATTIVATO**
Safety device disabled

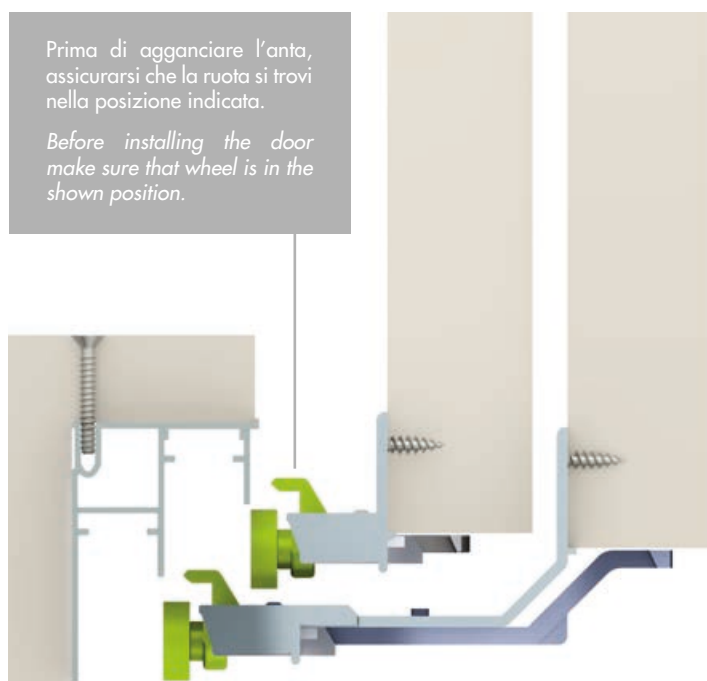

ANTISGANCIAMENTO **ATTIVATO**
Safety device activated



ALL THE FURNITURE HARDWARE



POZZI ferramenta

Più di 30.000 articoli commercializzati per il settore della ferramenta per mobili con oltre 64 paesi serviti.
More than 30.000 products marketed of furniture accessories with over 64 countries served.

SH System Holz

Produttore specializzato nello sviluppo di cerniere per mobili, sistemi scorrevoli e profili e ante in alluminio.
Manufacturer specialized in the development of hinges for furniture, sliding systems and aluminium doors and profile.

OXIDAL SYSTEM

Leader nella pulitura e ossidazione anodica di particolari in alluminio con 37 vasche e 2 forni di asciugatura.
Leading company in any type of surface treatment on aluminium materials, with 37 baths and 2 drying ovens.

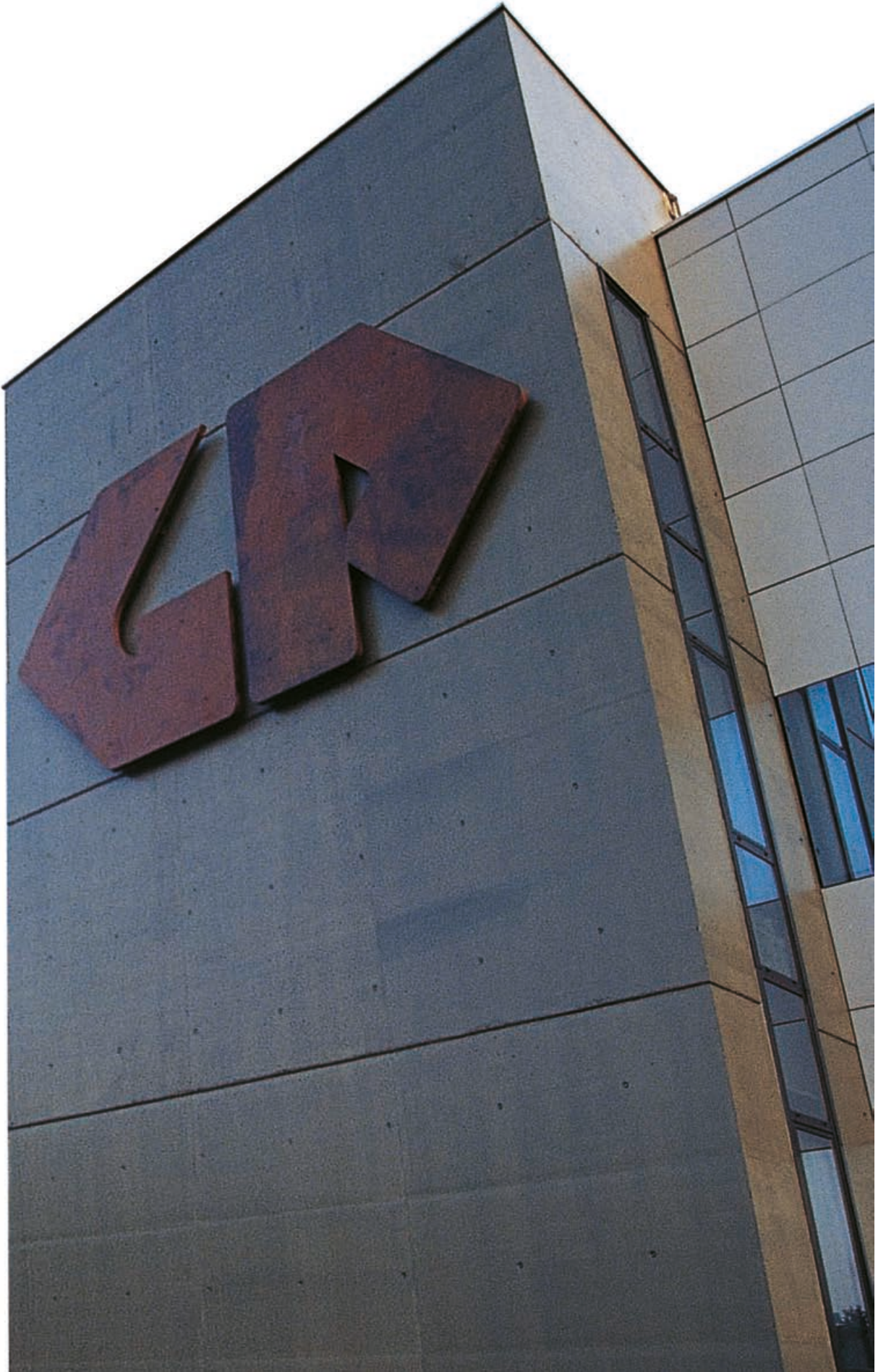

SH System Holz

SYSTEM HOLZ SRL

Via Valsorda, n.6
22040 Cremnago di Inverigo, (CO) ITALY
Tel. +39 031 6949111 - Fax. +39 031 698073
infosh@gruppopozzi.it - www.gruppopozzi.it

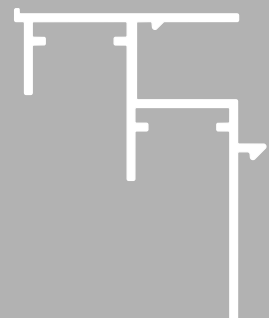
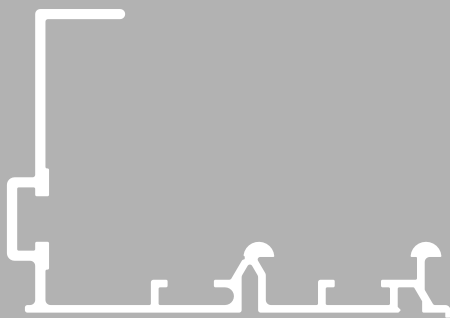

Gruppo Pozzi